

BASIC INFORMATION

Straumann® Mini Implant System

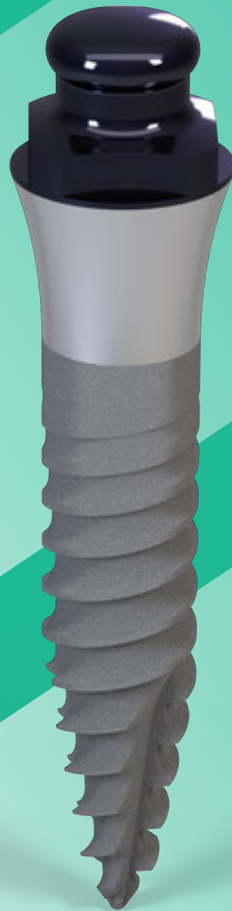

ABOUT THIS GUIDE

This surgical and prosthetic procedure describes the steps required for implantation and restoration of the Straumann® Mini Implant System. The Straumann® Mini Implant System is recommended for use only by clinicians with advanced surgical skills. It is assumed that the user is familiar with placing dental implants. Not all detailed information will be found in this guide. Reference to existing Straumann® procedure manuals will be made throughout this document.

Not all products shown are available in all markets.

CONTENTS

1. THE STRAUMANN® MINI IMPLANT SYSTEM	3
1.1 Portfolio overview	4
1.2 The Straumann® Mini Implant at a glance	5
1.3 Straumann® Optiloc® Retentive System	6
2. SURGICAL PROCEDURE	7
2.1 Preoperative planning	7
2.2 Surgical consideration	9
2.3 Instruments	10
2.4 Implant bed preparation	14
2.5 Surgical Workflow	15
3. PROSTHETIC PROCEDURE	19
3.1 Chairside modification of an existing well-fitting and well-functioning denture into an overdenture supported by Optiloc® Retentive System/Straumann® Mini Implants	19
3.2 Creating a new overdenture with the Optiloc® Retentive System	22
3.3 Soft Reline protocol when primary stability is not achieved on all implants	25
4. USING THE OPTILOC® TOOLS	26
4.1 Optiloc® Matrix Housing Extraction Instrument (Fig. 1)	26
4.2 Optiloc® Laboratory Instrument (blue) (Fig. 4)	26
4.3 Optiloc® Retention Insert Instrument (Fig. 8)	27
5. SPECIALLY FEATURED OPTILOC® COMPONENTS	28
6. PRODUCT REFERENCE LIST	29
6.1 Straumann® Mini Implants Roxolid® SLA®	29
6.2 Optiloc® Processing Package, Retention Inserts and Matrix Housings	30
6.3 Optiloc® tools and auxiliary parts	31
6.4 Straumann® Modular Cassette	31
7. FURTHER INFORMATION	32

1. THE STRAUMANN® MINI IMPLANT SYSTEM

The Straumann® Mini Implant System offers one-piece Tissue Level implants with an Optiloc® prosthetic connection. These are designed for narrow edentulous ridges and immediate treatment procedures (if at least 35 Ncm insertion torque is achieved in all implants) to stabilize full removable overdentures.







The Straumann® Mini Implants are made from the material Roxolid® with the SLA® surface and are available in the end-osteal diameters \varnothing 2.4 mm, with length options of 10 mm, 12 mm and 14 mm.













To obtain more information about indications and contraindications related to the implant, please refer to the corresponding instructions for use. Instructions for use can be found on www.ifu.straumann.com

1.1 PORTFOLIO OVERVIEW

Surgical components

					
<p>Straumann® Mini Implant GH 2.8 mm: 042.944S, 10 mm 042.945S, 12 mm 042.946S, 14 mm GH 3.8 mm: 042.950S, 10 mm 042.951S, 12 mm GH 4.8 mm: 042.952S, 10 mm 042.953S, 12 mm</p>	<p>Needle Drill, multi use: 026.0054, 026.0056 single use, sterile: 027.0006S, 027.0007S</p>	<p>Pilot Drill, multi use: 034.257, 034.258, 034.259 single use, sterile: 027.0011S</p>	<p>Optiloc® Adapter for Ratchet 170.2-OPT</p>	<p>Optiloc® Adapter for Handpiece 170.1-OPT</p>	<p>Paralleling Post 046.796</p>

Prosthetic components

				
<p>Optiloc® Model Analog 2102.0024-OPT</p>	<p>Matrix Housings 2102.0001-OPT 2102.0009-OPT 2102.0010-OPT</p>	<p>Retention Insert 2102.0003-OPT 2102.0004-OPT 2102.0005-OPT 2102.0006-OPT 2102.0007-OPT 2102.0008-OPT</p>	<p>Optiloc® Block Out Spacer 2102.0023-OPT</p>	<p>Optiloc® Processing Collar 2102.0011-OPT</p>
				
<p>Optiloc® Impression Coping 2102.0012-OPT</p>	<p>Optiloc® Matrix Housing Extraction Instrument 3202.0003-OPT</p>	<p>Optiloc® Laboratory Instrument 3202.0002-OPT</p>	<p>Optiloc® Retention Insert Instrument 3202.0001-OPT</p>	<p>Equipment Box with 3 Instruments 5102.0000-OPT</p>

1.2 THE STRAUMANN® MINI IMPLANT AT A GLANCE

Optiloc®:

- Minimized maintenance, narrow diameter
- Carbon-based coating (ADLC*) for good wear resistance

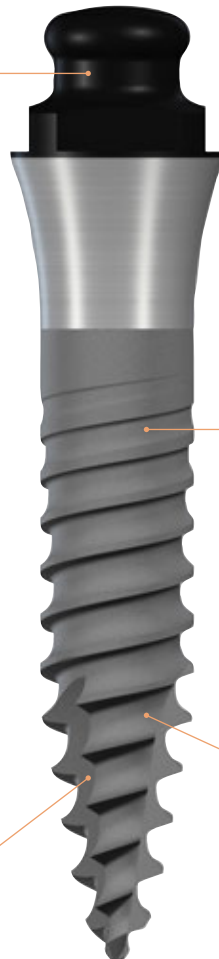

Roxid®:

- High material strength and biocompatibility
- Peace of mind with Straumann® Mini Implants

SLA®:

- Predictability in osseointegration
- Scientific evidence
- Low prevalence of peri-implantitis
- Bone preservation

Apically tapered implant body design allows underpreparation and supports a high primary stability

1.2.1 Material

Roxid® is a groundbreaking material specifically designed for the use in dental implantology. The titanium-zirconium alloy is stronger than pure titanium^{1,2} and has excellent osseointegration properties³⁻⁵. This combination of properties is unique in the market, there is no other metallic alloy which unifies high mechanical strength and osteoconductivity.

Thanks to their outstanding biological and mechanical properties, Roxid® Implants offer more treatment options than conventional titanium implants.

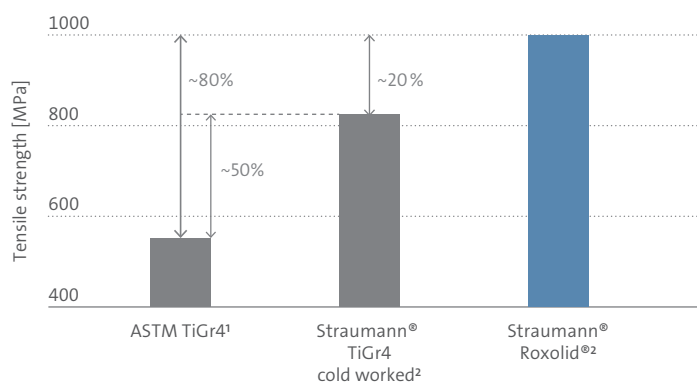

Roxid® shows a 20% higher tensile strength than Straumann® cold worked titanium and a 80% higher strength than standard titanium Grade 4.

* Amorphous Diamond-Like Carbon

1.3 STRAUMANN® OPTILOC® RETENTIVE SYSTEM

The Straumann® Optiloc® Retentive System for full removable overdentures offers an innovative carbon-based prosthetic connection coating (ADLC*) with an excellent wear resistance, overcoming up to 40° implant convergence or divergence. Together with its durable PEEK** matrices the Optiloc® Retentive System provides a unique and long-lasting attachment performance.

1.3.1 Straumann® Optiloc® Retentive System at a glance

1

- PEEK** Matrix Housings offering excellent chemical and physical properties
- Matrix accommodates up to 40° prosthetic divergence between two abutments
- 6 retention strengths offer optimal adjustment of the denture retention
- Matrix Housing available in titanium, or color-neutral PEEK** for a more aesthetic outcome

2

- Carbon-based abutment coating (ADLC*) offering a smooth surface and ultimate hardness for excellent wear resistance



The Optiloc® Matrix System allows a convergence, or divergence, of up to 20 degrees of each implant in relation to the denture's path of insertion. This means that divergences between two implants of a maximum of 40 degrees can be corrected.

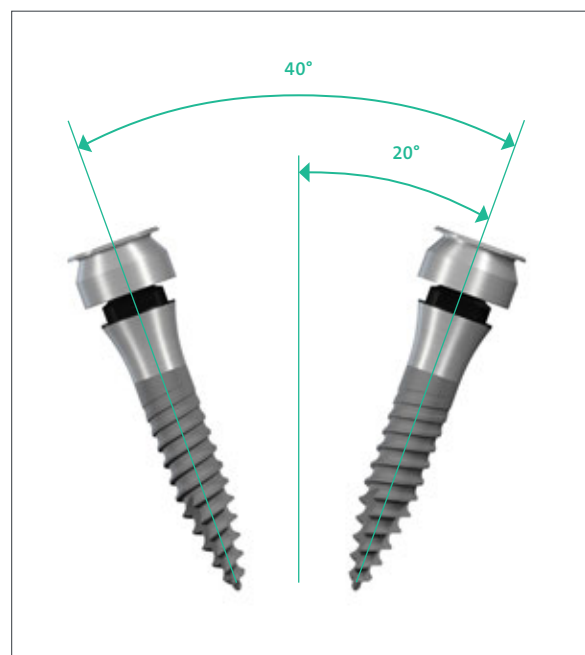

* Amorphous Diamond-Like Carbon
** Polyether ether ketone

2. SURGICAL PROCEDURE

The workflow for the surgical procedure for the Straumann® Mini Implant System involves 3 steps:

- Preoperative planning
- Implant bed preparation
- Implant insertion

2.1 PREOPERATIVE PLANNING

After patient selection and evaluation protocols have been completed, the number of Straumann® Mini Implants that should be placed (minimum of four in the mandible, minimum of six in the maxilla) are determined and thoroughly discussed with the patient. Information on bone availability for the implant bed of the patient and information of tissue depth mucosa thickness in the region of the prospected implant site by measuring with a perio probe should be available. After site selection, Straumann® Mini Implants should be placed at least 5 mm apart.

When anatomic conditions allow, distribute the number of implants along the arch in-order to minimize cantilever and to provide optimal load distribution/better load conditions. When the anatomic situation is not optimal for the mandible the implants should be placed beginning at least 5 mm anterior to the mental foramen. The remaining anterior space should be distributed equally between implants and respecting the minimum distance between implants (5 mm).

For maxillary placement, careful implant length selection must be followed to avoid anatomical structures such as nasal cavity and maxillary sinus.

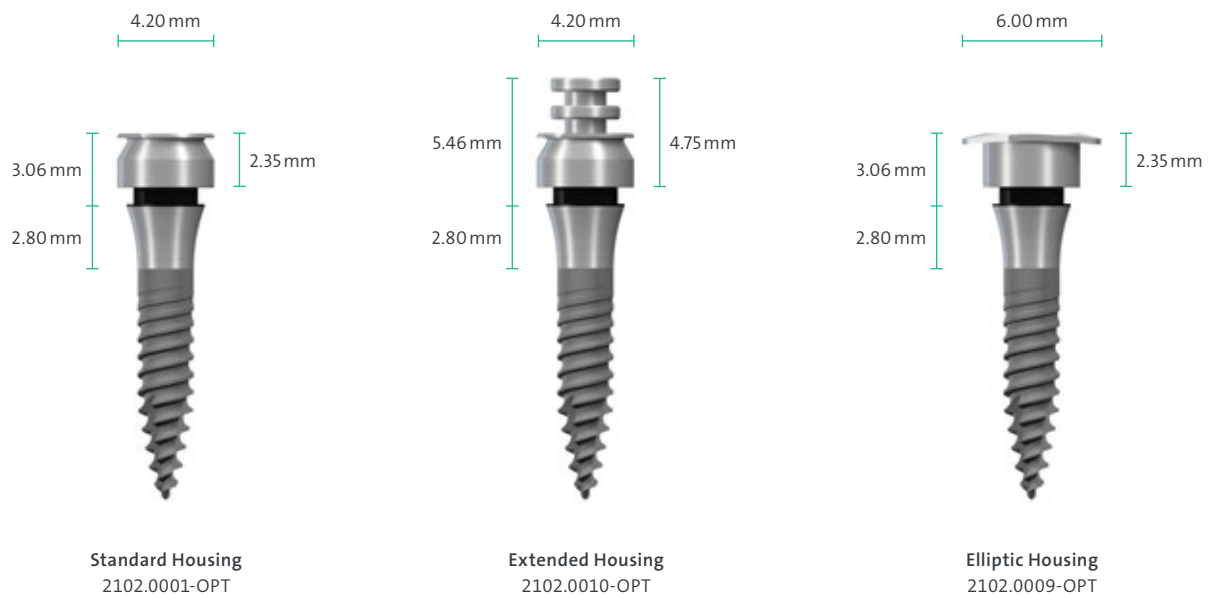

2.1.1 X-ray reference foil

The vertical bone availability determines the maximum allowable length of the implant that can be placed. For easier determination of the vertical bone availability, we recommend the use of an x-ray reference foil with X-ray Reference Sphere (Art. No. 049.076V4).

Similar to the distortions that occur in X-rays, the implant dimensions are shown on the individual templates with the corresponding distortion factors (1:1 to 17:1). Determining each magnification factor or scale is facilitated by showing the X-ray reference sphere on the template (next to the scale reference).

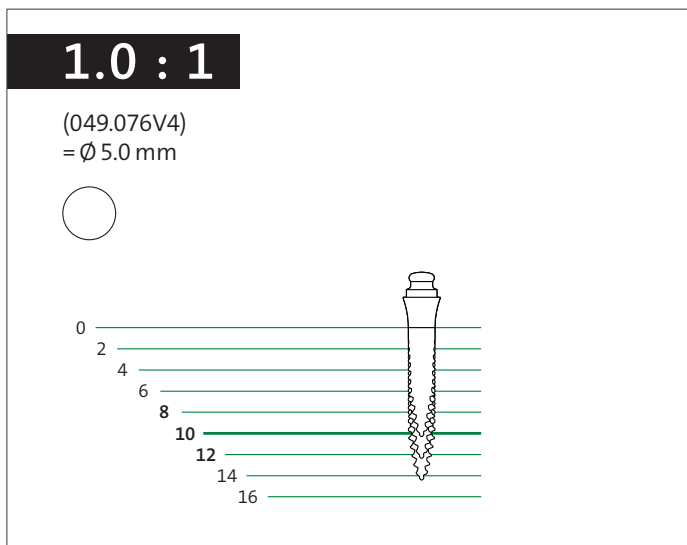

Note: Use only the x-ray template specific to the implant type.

To calculate the effective bone availability, use the following formula:

$$\frac{\text{X-ray Reference sphere 5 mm} \times \text{bone availability (X-ray*)}}{\text{Reference sphere diameter on the X-ray}} = \text{effective bone availability}$$

2.2 SURGICAL CONSIDERATION

Depending on the bone density (soft / medium / hard) different drill protocols should be applied for the Mini Implant. This provides the flexibility to adjust the implant bed preparation to the individual bone quality and anatomical situation.

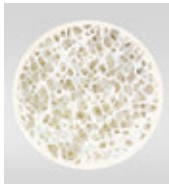
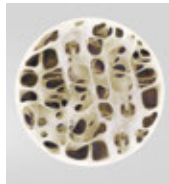
Cross sectional view of different types of bone quality*		
Type I	Type II/III	Type IV
Hard	Medium	Soft
Thick cortical bone with marrow cavity	Thin cortical bone with dense trabecular bone of good strength	Very thin cortical bone with low density trabecular bone of poor strength
		

	Bone Type			Soft tissue depth		Buccolingual width		
	Soft	Medium	Hard	< 2 mm	≥ 2 mm	< 4.4 mm	≥ 4.4 mm with flap	≥ 5.4 mm flapless*
2.4mm Straumann® Mini Implant	✗	✓	✓	✗	✓	✗	✓	✓

✗ Not recommended ✓ Recommended

* Flapless procedures have a higher planning inaccuracy. We recommend at least a ridge width of 5.4 mm for such interventions

This implant is contraindicated for soft bone. Additionally it is recommend that the treatment should only be conducted with patients that have more then 2 mm soft tissue depth and a buccolingual width of more than 4.4 mm. The procedure can be done flapless only if there is more then 5.4 mm buccolingual bone width.

* Lekholm U, Zarb G. Patient selection and preparation in Tissue Integrated Prostheses. Branemark P I, Zarb G A, Albrektsson T (eds). pp199–210. Quintessence, 1985.

2.3 INSTRUMENTS

2.3.1 Drills

The Straumann® instruments have depth marks at 2 mm intervals that correspond to the available implant lengths. The first bold mark on the drills represents 10 mm and 12 mm, where the lower edge of the mark corresponds to 10 mm and the upper edge to 12 mm. The drills can be ordered sterile as single use or unsterile as multi use.

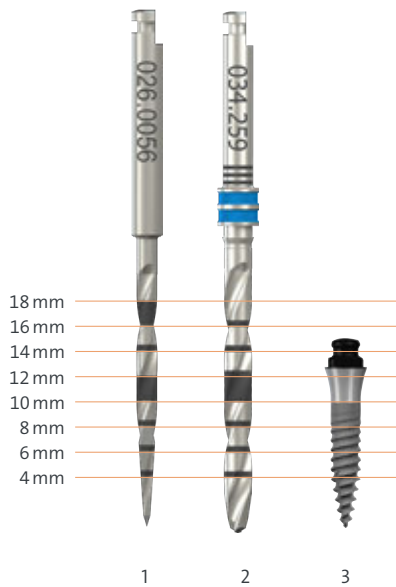

1. Drill: 026.0056 or 027.00075
2. Drill: 034.259 or 027.00115
3. Implant: 042.944S

2.3.2 Paralleling Post

The Paralleling Post (Art. no. 046.796) is an instrument used to ensure the correct, parallel positioning of the implant during implant bed preparation and to align with other implants.

The mid portion of the Paralleling Post represents the gingiva height/machined part of the implant.

Characteristics

- Ø1.6 mm
- Ø2.2 mm
- Height 2.8 mm (gingiva height implant)
- Material: TAV
- Delivered sterile

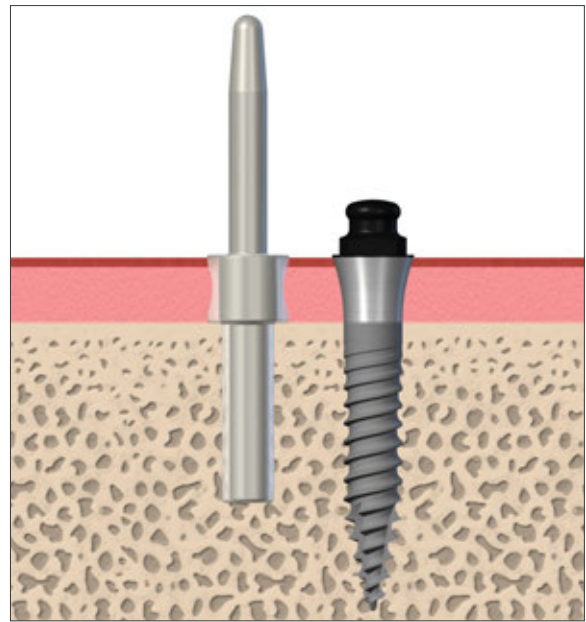

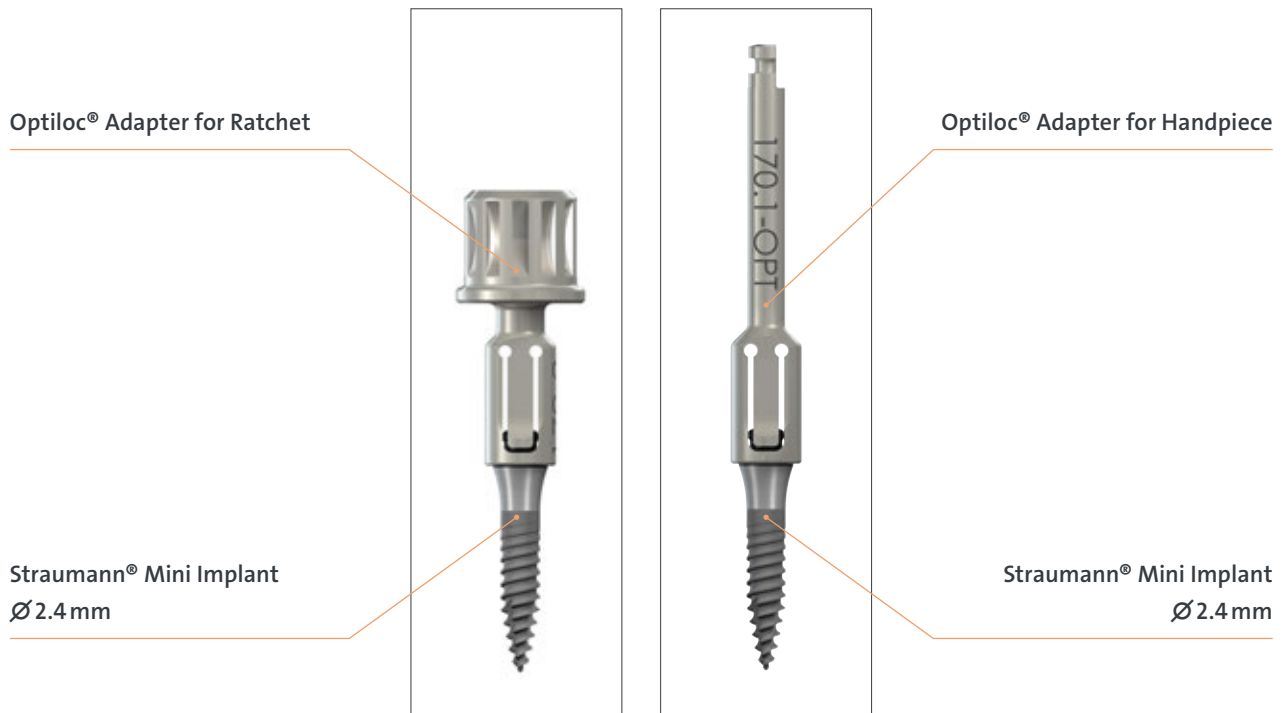

2.3.3 Adapter

Specific adapter to use for insertion of the Straumann® Mini Implants.



2.3.4 Ratchet and Torque Control Device

The Ratchet is a two-part lever arm instrument with a rotary knob for changing the direction of force. It is supplied with a service instrument, which is used to tighten and loosen the head screw. The Holding Key (046.064) can be used to stabilize the Ratchet.

Ratchet and Torque Control Devices			
	Holding Key	Ratchet	Torque Control Device for Ratchet, Surgical
			
Intended use	Auxilliary	Torque transmission	Surgical
Torque markings	NA	NA	0/35/50/80 Ncm
Article Number	046.064	046.119	066.1100
Material	Stainless steel	Stainless steel	Stainless steel, DLC coated

Note: To ensure prolonged perfect function, the Ratchet must always be taken apart and the individual parts disinfected, cleaned and sterilized after use. Its function must be checked in good time before each use.

2.3.5 Straumann® Modular Cassette

The Straumann® Modular Cassette is used for the sterilization and the secure storage of the surgical instruments and auxiliary instruments. For guidelines on how to clean and sterilize the cassette, please refer to *Straumann® Modular Cassette, Basic Information (702527/en)*.

2.3.6 Setup for Straumann® Mini Implant freehand surgery

For more information refer to *Straumann® Modular Cassette Selection Guide (702824/en)*.

A Module
041.761

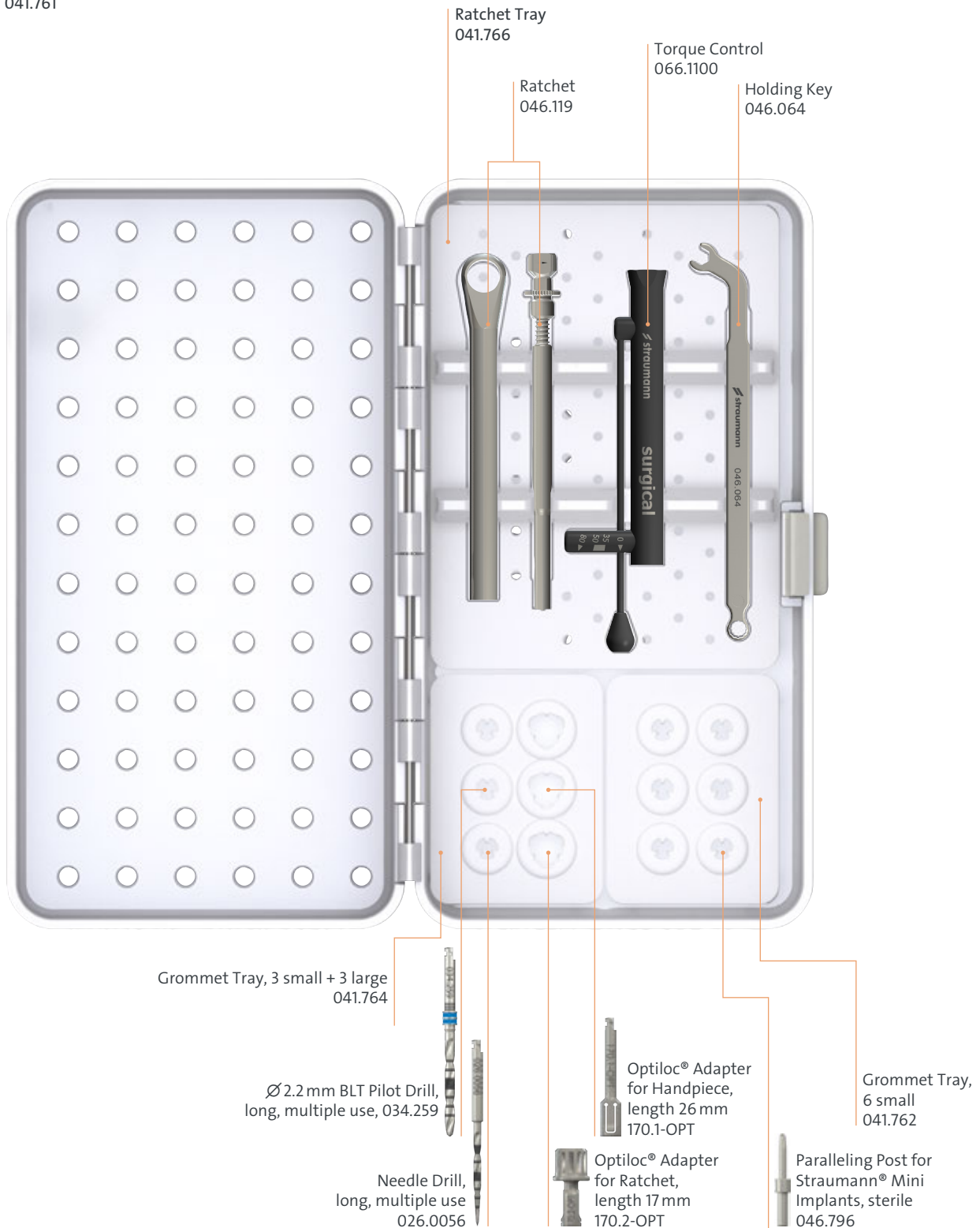

Caution: All sterile instruments are for single use only and can not be sterilize with the Modular Cassette and other instruments.

2.4 IMPLANT BED PREPARATION

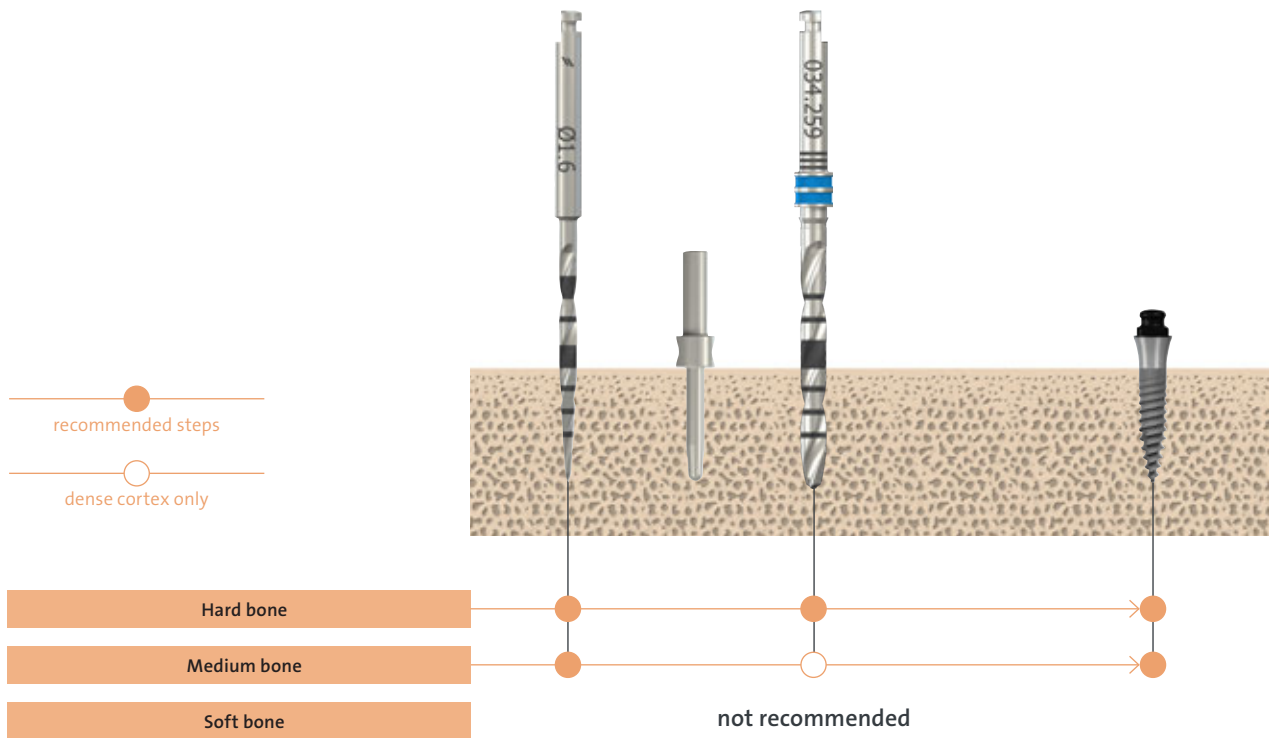

Recommended speed: rpm max 800

Note: In medium bone situation with dense cortex it is recommended to use the $\varnothing 2.2$ mm drill to prepare the cortical aspect of the osteotomy.

Hard Bone

- Use the $\varnothing 1.6$ mm Needle drill according to the full implant length.
- Evaluate Three-Dimensional position of the osteotomy with the use of the $\varnothing 1.6$ mm side of the parallel post.
- Use the $\varnothing 2.2$ mm Pilot Drill to the full implant length.
- Implant placement.

Medium Bone

- Use the $\varnothing 1.6$ mm Needle drill according to the full implant length.
- With dense cortex it is recommended to use the $\varnothing 2.2$ mm drill to prepare the cortical aspect of the osteotomy.
- Implant placement.

Soft Bone

Not recommended.

2.5 SURGICAL WORKFLOW



Step 1 – Gingival height assessment

With the use of a periodontal probe assess the thickness of the gingiva.

Note: consider the gingival height when drilling and reading the depth mark from the instruments



Step 2 – Marking of implant side

Mark the implantation site determined during the implant position planning with the Ø1.6 mm Needle Drill.

Thin ridge:

In presence of a thin ridge, the use of a round bur may be necessary and shall be used in order to level the bone before using the Ø1.6 mm Drill. In this case, a conventional flapped surgery needs to be done.



Step 3 – Implant axis

Drill with the Needle Drill to 4 mm.

Note: In case of vertically reduced bone availability, an x-ray should be taken at this step in order to be sure that drill does not pass through the mandibular basal bone.

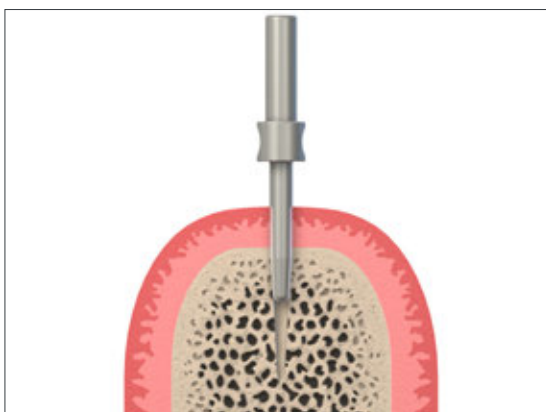

Use the Ø1.6 mm side of the Paralleling Post to check the implant axis.

Note: When opening the sterile pouch containing the tube with the paralleling post, ensure that the tube is securely seated on the surgical tray.

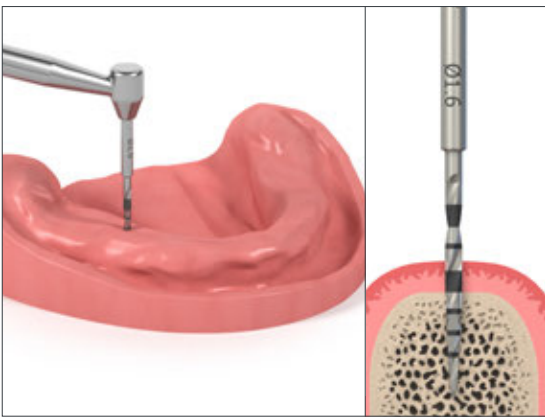

Step 4 – Site preparation

Drill the implant bed to the final depth with the $\varnothing 1.6$ mm Needle Drill, while correcting unsatisfactory implant axis orientation if necessary. In case of a hard cortex the drilling can be continued with the $\varnothing 2.2$ mm Pilot Drill to prepare the cortical aspect of the osteotomy.

For $\varnothing 2.4$ mm Straumann® Mini Implants in **medium bone**, the implant bed preparation ends here. In case of a hard cortex the drilling can be continued with the $\varnothing 2.2$ mm Pilot Drill to prepare the cortical aspect of the osteotomy.



Insert the $\varnothing 1.6$ mm Paralleling Post to check for correct implant axis orientation.

In hard bone: Drill the implant bed to the final depth with the $\varnothing 2.2$ mm BLT pilot drill.



Insert the $\varnothing 2.2$ mm side of the Paralleling Post to check for correct implant axis orientation.



Further implants, implant alignment:

Leave the parallel post as reference for the next implant bed preparation, and continue until all sites are prepared. Distribute the implants equally, respecting the minimum distance between implants (5 mm).

Note: Parallelism of the implants is essential.

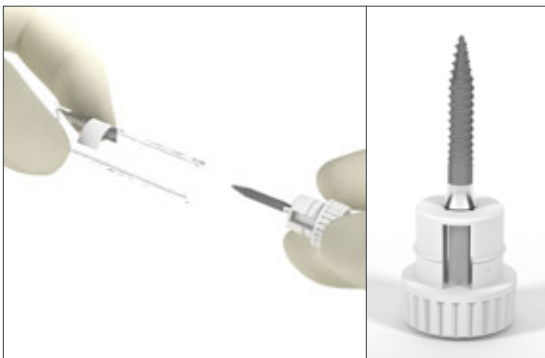

Step 5 – Implant placement

Straumann® Mini Implants are delivered in a sterile vial and mounted on the vial cap which serves as initial insertion tool.

Note: When opening the sterile blister, ensure that the sterile vial is securely seated on a sterile surgical tray.



Use of the vial cap as finger driver

Insertion of implant begins with the vial cap until more torque is necessary.

Caution: Please do not use implant if it is detached from the vial cap after opening of the blister.



Step 6 – Final implant positioning

Place implant

Straumann® Mini Implants can be placed with the Handpiece or manually with the Ratchet. A maximum speed of 15 rpm is recommended.

Use the Ratchet and/or Handpiece to move the implant into its final position turning it clockwise.

Final placement is achieved once the entire conditioned SLA® surface is engaged into the bone.

Do not exceed 80 Ncm insertion torque during implant placement as this may lead to implant damage.



Mandibular denture stabilization

A minimum of 4 Straumann® Mini Implants should be placed to stabilize a full mandibular denture.

Caution: Pay attention to the Inferior Alveolar Nerve, and the sub-lingual artery.

Note: Always start with the most distal implant at least 7 mm anterior to the mental foramen.



Maxillary denture stabilization

A minimum of 6 Straumann® Mini Implants should be placed to stabilize a full maxillary denture.

3. PROSTHETIC PROCEDURE

3.1 CHAIRSIDE MODIFICATION OF AN EXISTING WELL-FITTING AND WELL-FUNCTIONING DENTURE INTO AN OVERDENTURE SUPPORTED BY OPTILOC® RETENTIVE SYSTEM/ STRAUMANN® MINI IMPLANTS

Caution: It is a prerequisite, however, that the complete denture does not need to be relined by a dental technician.

This workflow illustration refers to a lower denture procedure. The upper denture follows the same steps.



Step 1 – Place white Processing Collar on each Optiloc®

The Processing Collar is used to block out the area surrounding the Optiloc®.

Then place a Matrix Housing with a Retention Insert (recommendation white, light) onto each Optiloc® abutment, leaving the white Processing Collar beneath it.



Step 2 – Prepare the complete denture

Hollow out the existing denture base in the areas of the Optiloc® Matrix Housings with Handpiece and resin bur. There should be a minimum space of 1 mm around the housings to allow for sufficient thickness of the self-polymerizing resin.



Step 3 – Seat denture

Use wash impression silicone to confirm adequate clearance between the Matrix Housings and the denture base.

Insert the complete denture into the patient's mouth and check the clearance. The Matrix Housings fixed on the abutments should not touch the denture base. Reconfirm adequate space using wash impression silicone. Adjust the denture base until seated passively in occlusion without touching the Matrix Housing.



Step 4 – Prepare denture

Apply proper adhesive/primer material in the denture prior to receiving the self-curing PMMA resin.



Step 5 – Polymerize the Matrix Housings

Fill the hollowed area with self-curing PMMA resin to polymerize the Matrix Housings in the denture.

Apply a small amount of acrylic resin to the tissue-contact surface of the denture and around the Matrix Housings. Insert the complete denture into the oral cavity.



Step 6 – Seat denture in occlusion

Once the complete denture is properly seated, maintain the patient in centric occlusion while the acrylic sets.



Step 7 – Discard Optiloc® Processing Collar

Once the resin has cured, remove the complete denture from the mouth and discard the white Optiloc® Processing Collar.

Put the complete denture in hot, but not boiling, water. Place it in a pressure pot when available.



Step 8 – Finish denture

After final curing, remove any excess acrylic and finish the denture base.

If needed, exchange the white, light Optiloc® Retention Insert with other Optiloc® Retention Inserts and insert the final overdenture into the patient's mouth.

3.2 CREATING A NEW OVERDENTURE WITH THE OPTILOC® RETENTIVE SYSTEM

This workflow illustration refers to a lower denture procedure. The upper denture follows the same steps.

Procedure in the dental office – Impression taking on abutment level



Step 1 – Placing the Optiloc® Impression Coping
Place the Impression Coping.



Step 2 – Impression taking
Use the mucodynamic technique for impression taking (vinyl polysiloxane or polyether rubber).

Send the impression to the dental lab.

Procedure in the dental lab

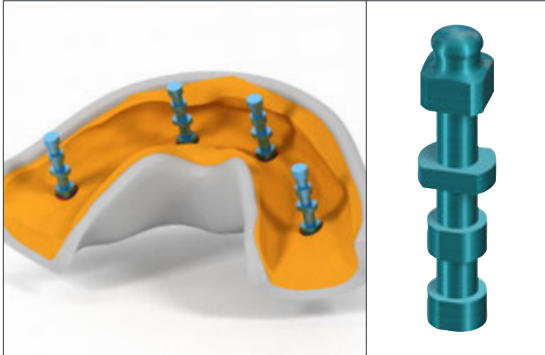

Step 1 – Inserting the Optiloc® Model Analog

Insert the Optiloc® Model Analog into the Optiloc® Impression Coping (see chapter 4 using the Optiloc® tools).



Step 2 – Fabricating the master cast

Pour a master model using standard methods and type-IV-dental stone (DIN 6873).

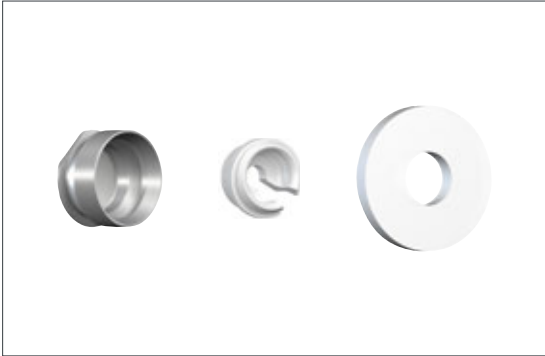

Step 3 – Placing the Optiloc® Processing Collar Matrix Housing

Place the Matrix Housing incl. a Retention Insert (e.g. 2102.0004-OPT, white, light) onto the Optiloc®.

For a chairside polymerization of the Optiloc® Matrix Housing use the Optiloc® Block Out Spacer to create the space needed.



Step 3.1 – Finalizing the new Optiloc® overdenture

Place white Processing Collar on all Optiloc® Model Analogs.



Step 3.2 – Processing the overdenture

Process the overdenture according to the standard procedures.



The dental lab will return the finalized Optiloc® overdenture to the dental office.

Procedure in the dental office



Step 4 – Seating the new Optiloc® overdenture

Select the appropriate Optiloc® Retention Insert (see chapter 5 Special featured Optiloc® components).



Step 4.1 – Selecting and inserting the Optiloc® Retention Inserts

Exchange the Optiloc® Retention Inserts to the Matrix Housing using the Retention Insert Instrument (brown) (see chapter 4 Using the Optiloc® Tools).



Step 4.2 – Seating the finished overdenture

Seat the finished overdenture.

3.3 SOFT RELINE PROTOCOL WHEN PRIMARY STABILITY IS NOT ACHIEVED ON ALL IMPLANTS

1. Grind down denture base from the existing denture at least 1mm and reline denture to accommodate the prosthetic heads of each implant. Important: At this step the implants heads must be absent of any contact.
2. Roughen and degrease the tissue-contact surface appropriately.
3. Apply soft relining material onto the tissue-contact surface of the denture.
4. Place the denture on the patient's mouth and ask patient to apply normal bite pressure in centric occlusion.
5. Allow proper setting time according to the relining material brand of choice.
6. Remove denture and trim excess material with fine scissors or a surgical blade. When available apply glazing material.
7. Do not remove the palate of a maxillary denture during this stage.
8. Ask patient to keep the denture in place for the first 48 hours after placement to prevent tissue overgrowth.
9. After an appropriate healing time, the soft reliner material is replaced with the final prosthesis. Please refer to Prosthetic workflow 3.1 and 3.2.
10. After osseointegration the palatal plate in maxillary denture can be progressively removed, if desired.

4. USING THE OPTILOC® TOOLS

4.1 OPTILOC® MATRIX HOUSING EXTRACTION INSTRUMENT (FIG. 1)

Removing the Optiloc® Matrix Housing from an overdenture

1. Heat the Optiloc® Matrix Housing Extraction Instrument head (Fig. 2).
2. Apply the hot Optiloc® Matrix Housing Extraction Instrument to the Matrix Housing and let the heat transfer for 2–3 seconds melting the resin around the Matrix Housing.
3. Tilt the Optiloc® Matrix Housing Extraction Instrument to the opposite side of the beak-shape end to remove the Optiloc® Matrix Housing (Fig. 3).

4.2 OPTILOC® LABORATORY INSTRUMENT (BLUE) (FIG. 4)

Placing the Optiloc® Model Analog

1. Pick up the Optiloc® Model Analog with the opposite side of the Optiloc® Laboratory Instrument (Fig. 5/6).
2. Position the Optiloc® Model Analog in the impression (Fig. 7).

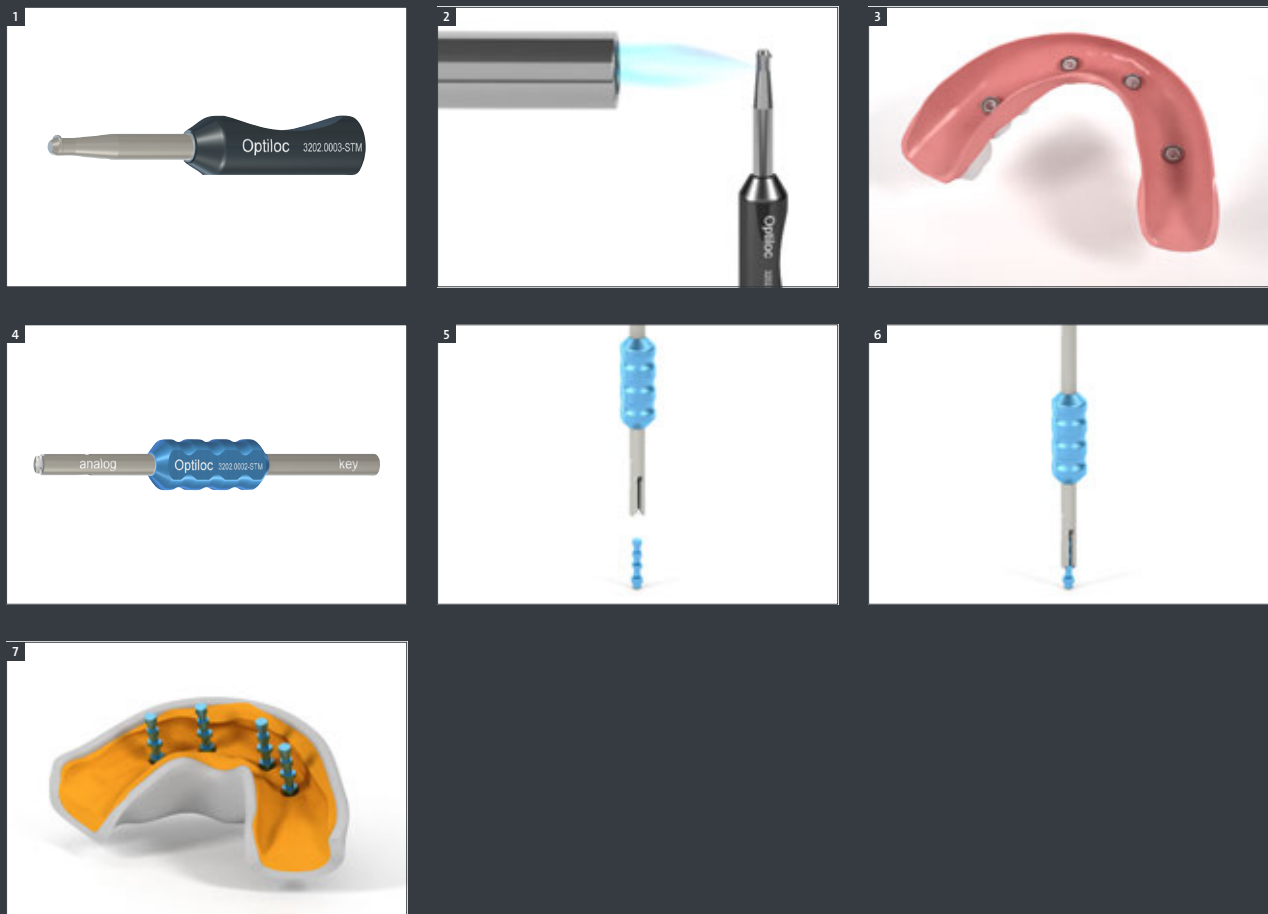

4.3 OPTILOC® RETENTION INSERT INSTRUMENT (FIG. 8)

Mounting the Optiloc® Retention Insert

1. Pick up the Optiloc® Retention Insert with the gripper end of the Optiloc® Retention Insert Instrument. The Optiloc® Retention Insert will lock on to the tool (Fig. 9).
2. Place the Optiloc® Retention Insert into the Optiloc® Matrix Housing (Fig. 10). The Optiloc® Retention Insert “clicks” into position (Fig. 11).

Demounting the Optiloc® Retention Insert

1. Apply the plunger end of the Optiloc® Retention Insert Instrument to the Optiloc® Retention Insert and engage with light pressure (Fig. 12/13).
2. Remove the Optiloc® Retention Insert from the Optiloc® Matrix Housing using a slight rotational movement (Fig. 14).
3. Use the special indentation in the handle of the Optiloc® Matrix Housing Extraction Instrument (Fig. 1) to remove the Optiloc® Retention Insert from the Optiloc® Retention Insert Instrument with a tilting movement (Fig. 15/16).

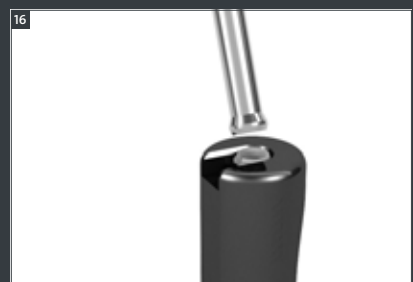
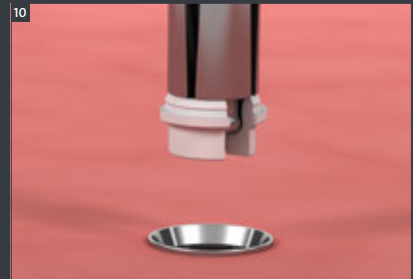

5. SPECIALLY FEATURED OPTILOC® COMPONENTS



Retention Insert color	Retention
● red, extra light	approx. 300 g
● white, light	approx. 750 g
● yellow, medium	approx. 1200 g
● green, strong	approx. 1650 g
● blue, extra-strong	approx. 2100 g
● black, ultra-strong	approx. 2550 g

Optiloc® Retention Inserts

The Optiloc® Matrix System allows a convergence, or divergence, of up to 20 degrees of each implant in relation to the denture's path of insertion.

Note:

It is recommended to use the light retention force first (white). In case it feels too loose for the patient, exchange with inserts with a higher retention force.



Optiloc® Processing Collar

The Processing Collar blocks out the area surrounding the abutment, preventing resin or a bonding agent from flowing into the Matrix Housing and embedding the abutment.

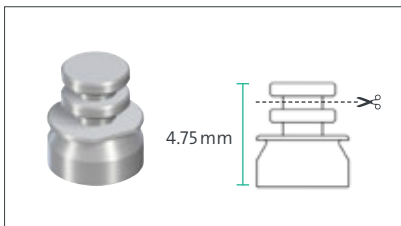

Optiloc® Matrix Housing - Extended

This Matrix Housing - Extended offers an extended attachment option. It is used for low-lying abutment heights or in situations requiring more retention. The attachment may be shortened according to the required height.























Optiloc® Block Out Spacer











The Optiloc® Block Out Spacer is a placeholder for the Optiloc® Matrix Housing. It is used for the model cast, cast metal-reinforced denture or if the Optiloc® Matrix Housing is to be polymerized into the overdenture chairside.

6. PRODUCT REFERENCE LIST













6.1 STRAUMANN® MINI IMPLANTS ROXOLID® SLA®

Art. No.		Article
Straumann® Mini Implants		
042.9445		Straumann® Mini Implant, GH 2.8 mm, Ø 2.4 mm, SLA®, ADLC, Roxolid®, 10 mm
042.9505		Straumann® Mini Implant, GH 3.8 mm, Ø 2.4 mm, SLA®, ADLC, Roxolid®, 10 mm
042.9525		Straumann® Mini Implant, GH 4.8 mm, Ø 2.4 mm, SLA®, ADLC, Roxolid®, 10 mm
042.9455		Straumann® Mini Implant, GH 2.8 mm, Ø 2.4 mm, SLA®, ADLC, Roxolid®, 12 mm
042.9515		Straumann® Mini Implant, GH 3.8 mm, Ø 2.4 mm, SLA®, ADLC, Roxolid®, 12 mm
042.9535		Straumann® Mini Implant, GH 4.8 mm, Ø 2.4 mm, SLA®, ADLC, Roxolid®, 12 mm
042.9465		Straumann® Mini Implant, GH 2.8 mm, Ø 2.4 mm, SLA®, ADLC, Roxolid®, 14 mm
Auxiliary Parts		
046.796		Paralleling Post for Straumann® Mini Implants, sterile
170.1/170.1-OPT		Optiloc® Adapter for Handpiece, length 26 mm
170.2/170.2-OPT		Optiloc® Adapter for Ratchet, length 17 mm
027.00065		Needle Drill, short, single-use
027.00075		Needle Drill, long, single-use
026.0054		Needle Drill, short, multi-use
026.0056		Needle Drill, medium, multi-use
027.00115		BLT Pilot Drill, long, Ø 2.2 mm, single-use, TAN
034.257		BLT Pilot Drill, short, Ø 2.2 mm, multi-use, TAN
034.258		BLT Pilot Drill, long, Ø 2.2 mm, multi-use, TAN
034.259		BLT Pilot Drill, long, Ø 2.2 mm, multi-use, TAN
2102.0024-OPT		Optiloc® Model Analog, blue, 4 pcs.
2102.0012-OPT		Optiloc® Impression Coping, white, 4 pcs.

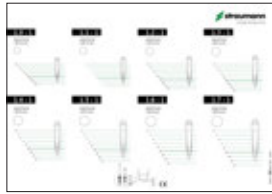
6.2 OPTILOC® PROCESSING PACKAGE, RETENTION INSERTS AND MATRIX HOUSINGS

Art. No.		Article
Processing Package		
5202.0001-OPT		Optiloc® Processing collar, 2 pcs. Optiloc® Matrix Housing, titanium, 2 pcs. Optiloc® Retention Insert, white, light, 2 pcs. Optiloc® Retention Insert, yellow, medium, 2 pcs. Optiloc® Retention Insert, green, strong, 2 pcs. Optiloc® Processing Collar, silicone, 2 pcs.
Retention Inserts		
2102.0003-OPT		Optiloc® Retention Insert, red, extra-light, 4 pcs.
2102.0004-OPT		Optiloc® Retention Insert, white, light, 4 pcs.
2102.0005-OPT		Optiloc® Retention Insert, yellow, medium, 4 pcs.
2102.0006-OPT		Optiloc® Retention Insert, green, strong, 4 pcs.
2102.0007-OPT		Optiloc® Retention Insert, blue, extra-strong, 4 pcs.
2102.0008-OPT		Optiloc® Retention Insert, black, ultra-strong, 4 pcs.
Matrix Housings		
2102.0001-OPT		Optiloc® Matrix Housing, 4 pcs.
2102.0009-OPT		Optiloc® Matrix Housing - Elliptic, 4 pcs.
2102.0010-OPT		Optiloc® Matrix Housing - Extended, 4 pcs.

6.3 OPTILOC® TOOLS AND AUXILLIARY PARTS

Art. No.		Article
5102.0000-OPT		Optiloc® Equipment Box, with 3 Instruments Optiloc® Laboratory Instrument (blue) Optiloc® Retention Insert Instrument (brown) Optiloc® Matrix Housing Extraction Instrument (gray)
2102.0023-OPT		Optiloc® Block Out Spacer, white, 4 pcs.
2102.0011-OPT		Optiloc® Processing Collar, silicone, 10 pcs.
3202.0001-OPT		Optiloc® Retention Insert Instrument
3202.0002-OPT		Optiloc® Laboratory Instrument
3202.0003-OPT		Optiloc® Matrix Housing Extraction Instrument
046.795		X-ray Reference Foil for Straumann® Mini Implants
049.076V4		X-ray Reference Spheres, Ø5 mm, stainless steel
046.119		Ratchet, including service instrument, length 84 mm, stainless steel
066.1100		Torque Control Device for Ratchet – surgical, stainless steel
046.064		Holding Key, length 85 mm, stainless steel
045.111V4		Cleaning Brush for Ratchet, length 100 mm, Ø4.5 mm, stainless steel/nylon

6.4 STRAUMANN® MODULAR CASSETTE

Art. No.		Article
041.761		Straumann® Modular Cassette, A Module
041.766		A Module, Ratchet Tray
041.764		A Module, Grommet Tray, 3 x small + 3 x large
041.762		A Module, Grommet Tray, 6 x small

7. FURTHER INFORMATION

For more detailed information on the instructions for use, please consult the following documents:

- *Instructions for Use: Straumann® Mini Implants (702198)* <http://ifu.straumann.com>
- *Instructions for Use: Straumann® Novaloc® and Optiloc® Martrix System (704486)* <http://ifu.straumann.com>
- *Instructions for Use: Optiloc®* <http://ifu.valoc.ch/>
- *Straumann® Surgical and Prosthetic Instruments, Care and Maintenance (702000/en)*
- *Straumann® Modular Cassette, Basic Information (702527/en)*
- *Instructions for Use: Straumann® Non-sterile Surgical Instruments and Auxiliaries (701124)* <http://ifu.straumann.com>
- *Instructions for Use: Straumann® Prosthetic Planning and Placement Tools (702879)* <http://ifu.straumann.com>
- *Instructions for Use: Straumann® Impression Components (703287)* <http://ifu.straumann.com>

¹ Norm ASTM F67 (states min. tensile strength of annealed titanium). ² Data on file for Straumann® cold-worked titanium and Roxolid® Implants, MAT 13336, 20131009. ³ Gottlow J et al. : Evaluation of a new titanium-zirconium dental implant: a biomechanical and histological comparative study in the mini pig. *Journal of Clinical Implant Dentistry and Related Research* 2012; 14: 538-545 ⁴ Wen B et al. : The osseointegration behavior of titanium-zirconium implants in ovariectomized rabbits. *Clin Oral Implants Res.* 2013 Feb 21. ⁵ Barter S et al. : A pilot study to evaluate the success and survival rate of titanium-zirconium implants in partially edentulous patients: results after 24 months of follow-up. *Clin Oral Implants Res.* 2012 Jul;23(7):873-81

International Headquarters

Institut Straumann AG

Peter Merian-Weg 12

CH-4002 Basel, Switzerland

Phone +41 (0)61 965 11 11

Fax +41 (0)61 965 11 01

www.straumann.com

© Institut Straumann AG, 2024. All rights reserved.

Straumann® and/or other trademarks and logos from Straumann® mentioned herein are the trademarks or registered trademarks of Straumann Holding AG and/or its affiliates.

